

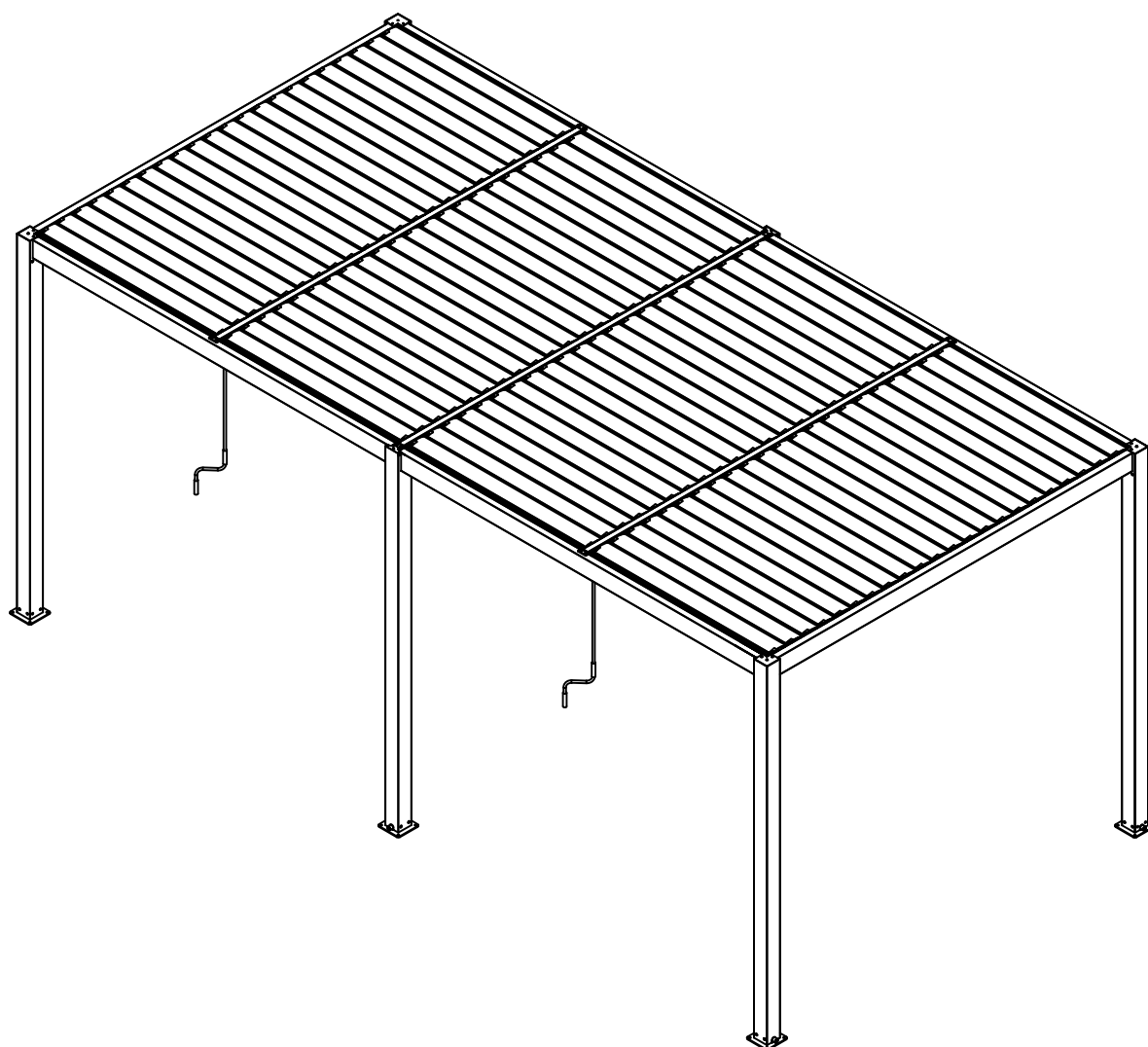







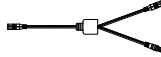
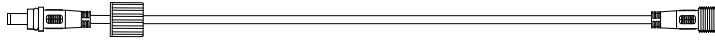
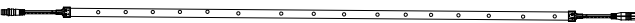
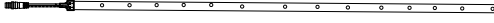
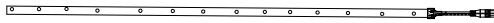

## Installation Instructions for 8610E with LED Light

5.8\*3M 5.8\*4M 7.8\*3M 7.8\*4M



# Bill of Materials List

No.	Component Name	Component Diagram	Quantity
1	12V Switching Power Supply & Controller Power Cords & Power Cords	 double-headed	1
2	LED Controller & LED Power Cord 500MM		2
3	8400 Three-Way		2
4	Two Core Coaxial Extension Cord with Male & Female Ends		1
5	Strip 1		2
6	Strip 2		2
7	Strip 3		2
8	Lampshade 1		2
9	Lampshade 2		4
10	Cable Press Block		12
11	Cable Press Block Screw		12
12	Cable Card		5.8*3M 60 5.8*4M 66 7.8*3M 72 7.8*4M 78
13	Cross-recessed Self Drilling & Tapping Screw	 ST4, 2*25	6
14	Single Key Remote		1

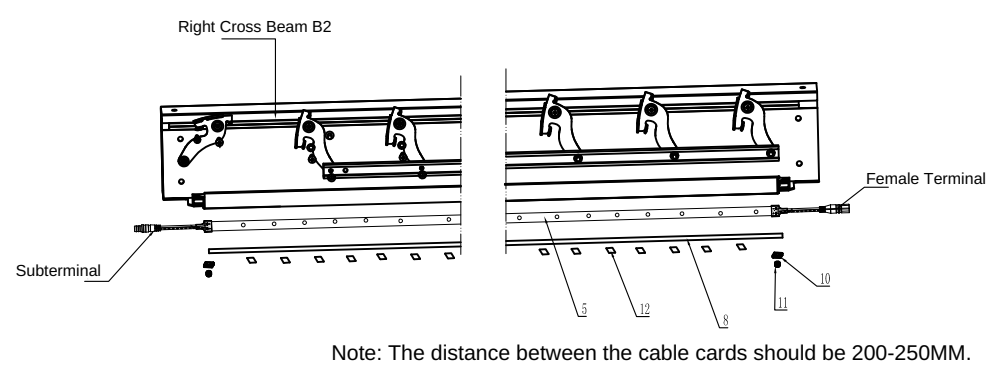
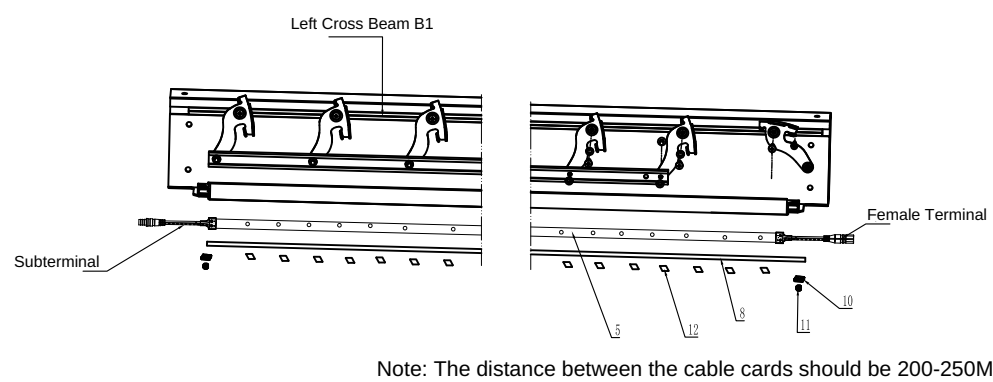
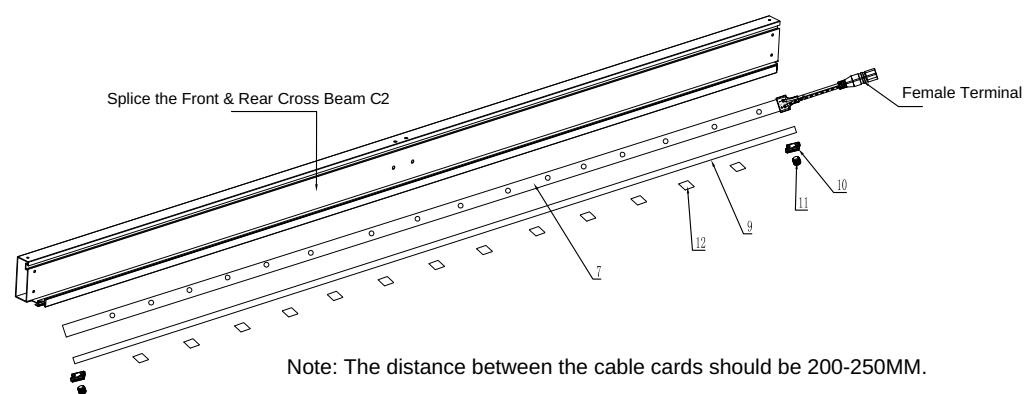
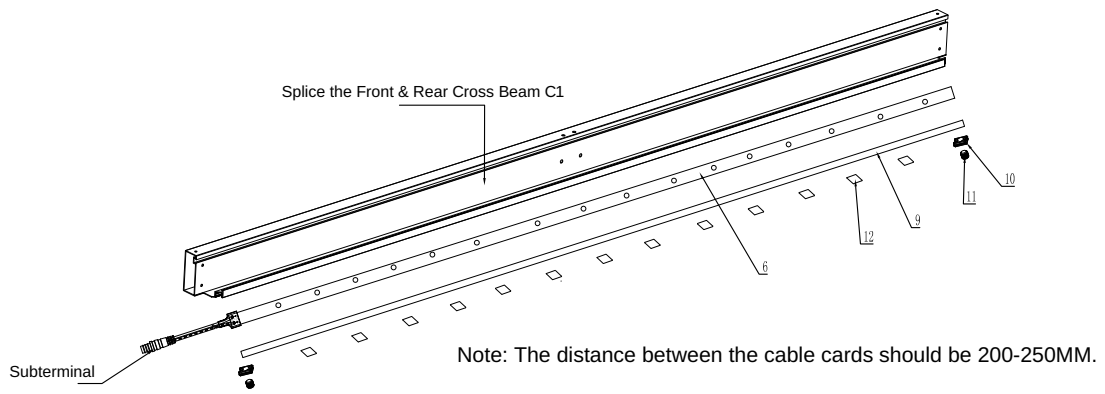

Install the switch power supply and controller, and connect the LED strip. After connecting the strip, connect it to the power source and adjust the single key remote 14 to change the brightness of the strip. The installation is complete.

